



Maestro Heritage

GSM GPRS Modem
850 / 900 / 1800 / 1900

USER MANUAL

Rev. 03



REVISION HISTORY

Rev.	Date	Details	Originated by
00	11 Sept 2007	First release	K.K Chan
01	04 Oct 2007	Second release	K.K Chan
02	04 Jan 2008	Third release	K.K Chan
03	28 Jan 2008	Fourth release	Cecile Lin

This manual is written without any warranty.

Maestro Wireless Solution Ltd. reserves the right to modify or improve the product and its accessories which can also be withdrawn without prior notice.

Besides, our company stresses the fact that the performance of the product as well as accessories depends not only on the proper conditions of use, but also on the environment around the places of use.

Maestro Wireless Solution Ltd. assumes no liability for damage incurred directly or indirectly from errors, omissions or discrepancies between the modem and the manual.

Confidential, the whole present document is the sole property of Maestro Wireless Solution Limited.



TABLE OF CONTENTS

REVISION HISTORY.....	1
TABLE OF CONTENTS.....	2
SAFETY PRECAUTIONS.....	3
Using the modem in vehicle.....	3
Protecting your modem.....	3
CHAPTER 1: Introduction.....	4
1. Package.....	4
2. Interfaces.....	4
a. Status indicator.....	4
b. SMA female antenna connector.....	5
c. 9-Pin D-Sub Female connector (RS232).....	5
d. 4-Pin connector (Power input).....	6
3. Optional accessories.....	6
CHAPTER 2: INSTALLATION.....	7
1. Install the SIM card.....	7
2. Connect the external antenna (SMA type).....	7
3. Connect the modem to external device.....	8
4. Connect the DC power supply.....	8
CHAPTER 3: WORKING WITH MAESTRO HERITAGE.....	9
1. Checking the modem (using Microsoft Windows XP HyperTerminal as example).....	9
2. Basic operation.....	11
CHAPTER 4: SPECIFICATIONS.....	12
CHAPTER 5: APPENDIX.....	13
CHAPTER 6: TROUBLESHOOTING.....	14
1. The modem's LED does not light.....	14
2. The modem's LED lights but does not blink long time after power up.....	14
3. The modem does not respond to the terminal program.....	14

SAFETY PRECAUTIONS

- The modem generates radio frequency (RF) power. When using the modem care must be taken on safety issues related to RF interference as well as regulations of RF equipment.
- Do not use your phone in aircraft, hospitals, petrol stations or in places where using GSM products is prohibited.
- Be sure that the modem will not be interfering with nearby equipment. For example: pacemakers or medical equipment. The antenna of the modem should be away from computers, office equipment, home appliance, etc.
- An external antenna must be connected to the modem for proper operation. Only used approved antennas with the modem. Please contact authorized dealer on finding an approved antenna.
- Always keep the antenna with minimum safety distance of 26.6 cm or more from human body. Do not put the antenna inside metallic box, containers, etc.

Using the modem in vehicle

- Check for any regulation or law authorizing the use of GSM in vehicle in your country before installing the modem
- Install the modem by qualified personnel. Consult your vehicle dealer for any possible interference of electronic parts by the modem.
- The modem should be connected to the vehicle's supply system by using a fuse-protected terminal in the vehicle's fuse box
- Be careful when the modem is powered by the vehicle's main battery. The battery may be drained after extended period.

Protecting your modem

- To ensure error-free usage, please install and operate your modem with care. Do remember the following:
- Do not expose the modem to extreme conditions such as high humidity/rain, high temperatures, direct sunlight, caustic/harsh chemicals, dust, or water.
- Do not try to disassemble or modify the modem. There is no user serviceable part inside and the warranty would be void.
- Do not drop, hit or shake the modem. Do not use the modem under extreme vibrating condition.
- Do not pull the antenna or power supply cable. Attach/ detach by holding the connector.
- Connect the modem only according to the instruction manual. Failure to do it will void the warranty.

Confidential, the whole present document is the sole property of Maestro Wireless Solution Limited.

CHAPTER 1: Introduction

Maestro Heritage is a ready-to-use GSM modem for data, fax and SMS services. It also supports GPRS (Class 10) and EDGE for hi-speed data transfer. Maestro Heritage can be easily controlled by using AT command for all kinds of operations. With standard 9 - pin RS232 port, the Maestro Heritage can be set up with minimal effort.

Maestro Heritage also having an Expansion Slot to make the modem becomes even more powerful. Add-on unit such as Input/Output, Ethernet Router and GPS etc...

1. Package

The Maestro Heritage package should include the following:

- Maestro Heritage x 1
- Power cord with fuse x 1
- Safety note x 1

2. Interfaces

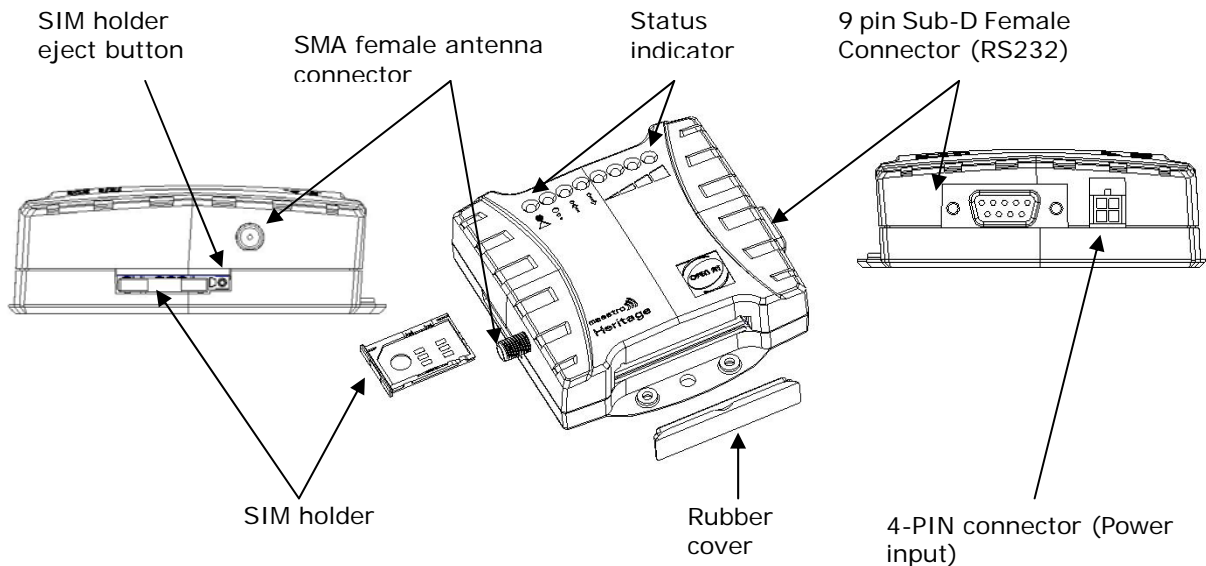

a. Status indicator

The LED will indicate different status of the modem:

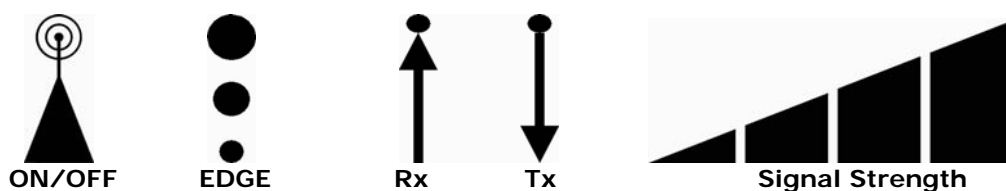

Confidential, the whole present document is the sole property of Maestro Wireless Solution Limited.

Name	Descriptions
Signal Strength	Strong (CSQ 27 or higher)
Signal Strength	Medium (CSQ 23 – 26)
Signal Strength	Low (CSQ 14 – 22)
Signal Strength	Weak (CSQ 1 – 13)
Rx	Data receive over TCP/UDP
Tx	Data transmit over TCP/UDP
EDGE	Availability of EDGE
GSM Status	OFF – Modem is off On – Modem is not registered to GSM network Slow blinking – Modem is registered to GSM network Fat blinking – Modem is in GSM communication

b. SMA female antenna connector

Connect this to an external antenna with SMA male connector. Make sure the antenna is for the GSM 900 / 1800 or GSM 850 / 1900 frequency with impedance of 50ohm, and also connector is secured tightly.

c. 9-Pin D-Sub Female connector (RS232)

The connector provides serial link to the modem

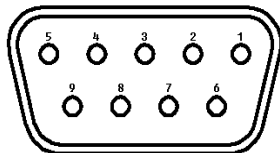

Sub-D 9 pin

Pin number	Name	EIA designation	Type
1	DCD	Data Carrier Detect	Output
2	RXD	Receive Data	Output
3	TXD	Transmit Data	Input
4	DTR	Data Terminal Ready	Input
5	GND	Ground	Ground
6	DSR	Data Set Ready	Output
7	RTS	Request To Send	Input
8	CTS	Clear To Send	Output
9	RI	Ring Indicator	Output

d. 4-Pin connector (Power input)

A cable, included in the package shall be used for power supply connection:

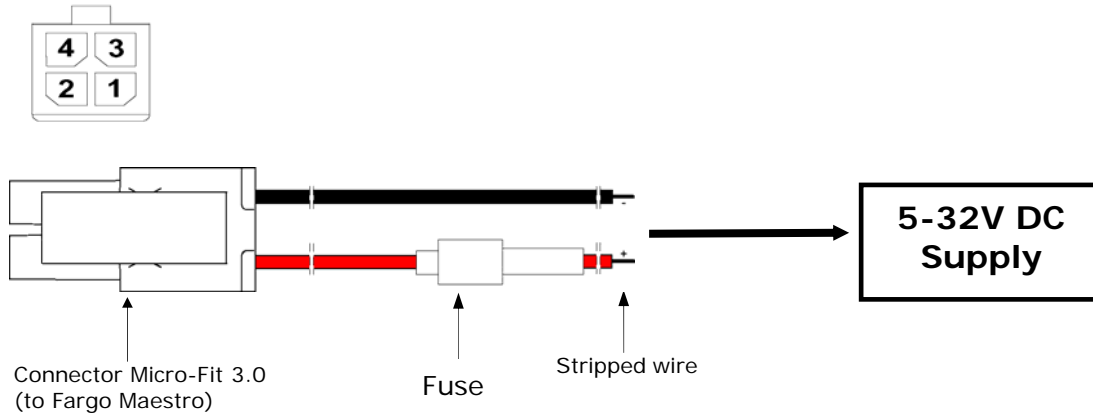

Pin assignment of 4-Pin connector

Pin number	Name	Functions
1	Not used	None
2	Not used	None
3	POWER -	DC power negative input
4	POWER +	DC power positive input

3. Optional accessories

You may contact your sales agent for the following optional accessories:

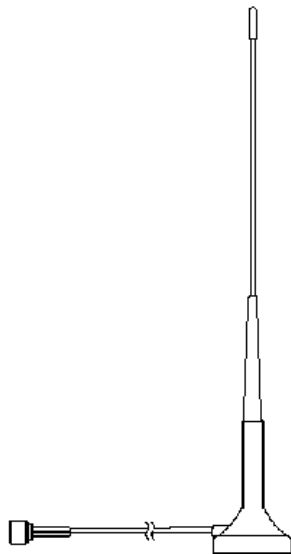

External antenna

- Magnetic mount type
- Frequency GSM 900/1800 band (3dBi)
- Frequency GSM 850 / 1900 band (0dBi)
- VSWR < 1.5:1
- Height ~ 236 mm (including magnetic base)
- Cable: Type RG-174U length 2.5m
- SMA male connector on cable end
- Color: back (SMA connector silver)

RS232 Cable

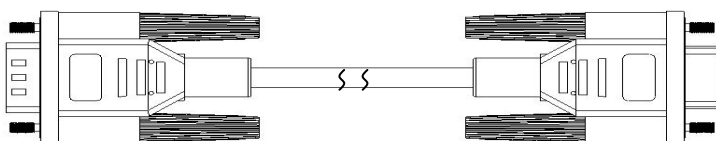

- Direct connection with standard 9-pin RS-232 port (DTE)
- Shielded cable
- Cable length 1.1m (w/ connector)

CHAPTER 2: INSTALLATION

1. Install the SIM card

Use a ball pen or paper clip to press the SIM holder eject button. The SIM holder will come out a little. Then take out the SIM holder.

Note: DO NOT pull out the SIM holder without pushing the ejector.

Put the SIM card to the tray; make sure it has completely sat on the tray. Put the tray back into the slot.

2. Connect the external antenna (SMA type)

Connect this to an external antenna with SMA male connector. Make sure the antenna is for the GSM 900/1800 or GSM 850 / 1900 frequency with impedance of 50ohm, and also connector is secured tightly.

Note: Please use antenna designed for GSM 900/1800 or GSM 850 / 1900 MHz operation. Incorrect antenna will affect communication and even damage the modem.

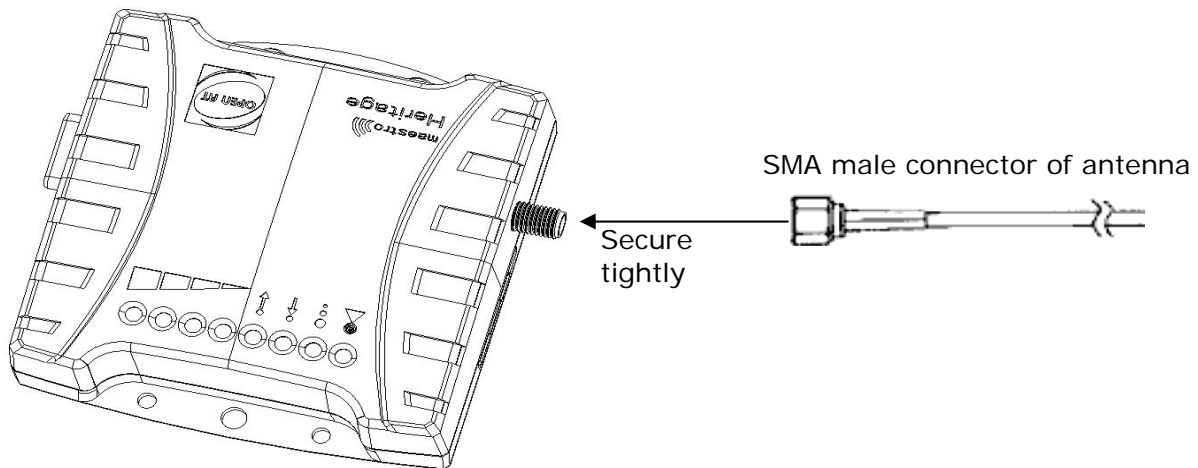

3. Connect the modem to external device

You can use the RS232 cable to connect the modem's Sub-D connector to external controller/computer.

Connection example using RS232 cable:

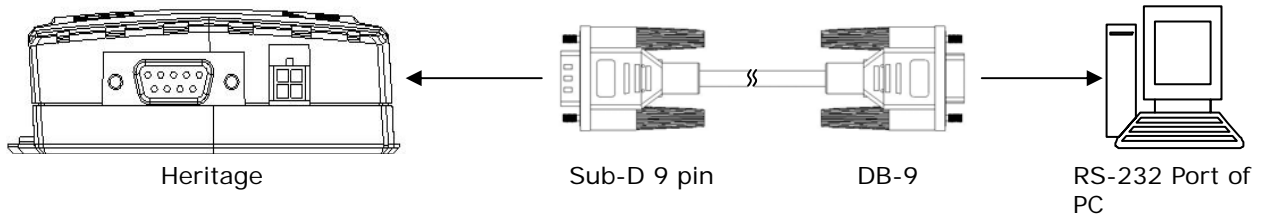

4. Connect the DC power supply

Connect the open ending of the inducted power cord to a DC supply. Refer to the following for power supply requirement.

Input voltage range	5V – 32V
Rated current	500 mA

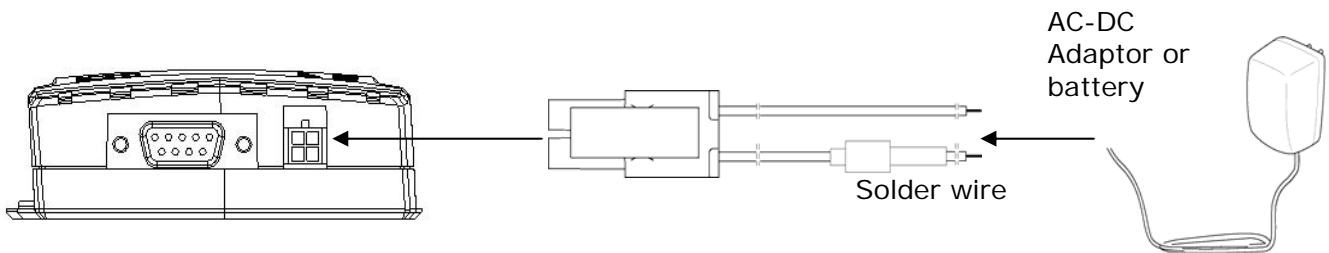

Connect the connector to the modem. The modem will turn on automatically.

The status indicator on the modem will be lit when power on. After a few seconds it will go flashing slowly (registered to the network successfully refer 1.2.1).

CHAPTER 3: WORKING WITH MAESTRO HERITAGE

1. *Checking the modem (using Microsoft Windows XP HyperTerminal as example)*

- a. On the first time power-up you can use terminal software to communicate with the modem through an RS232 serial port. Following example is using the HyperTerminal in Windows XP.

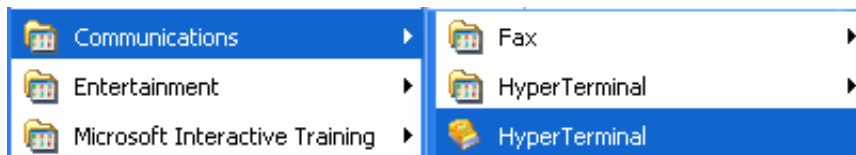

- b. On Windows XP, start the HyperTerminal program. Assign a name for a new session.



- c. Choose the correct Com port and baud rate settings (9600bps for Eco; 115200bps for others, 8bits, no parity bit, 1 stop bit)

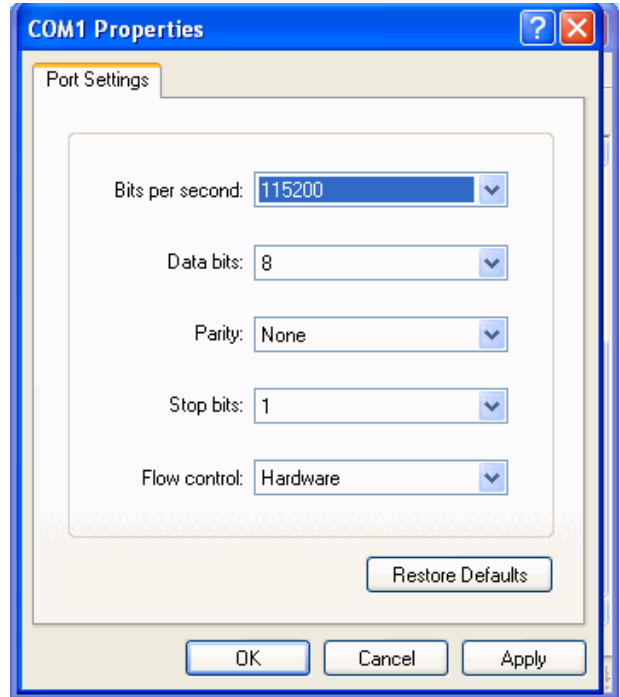
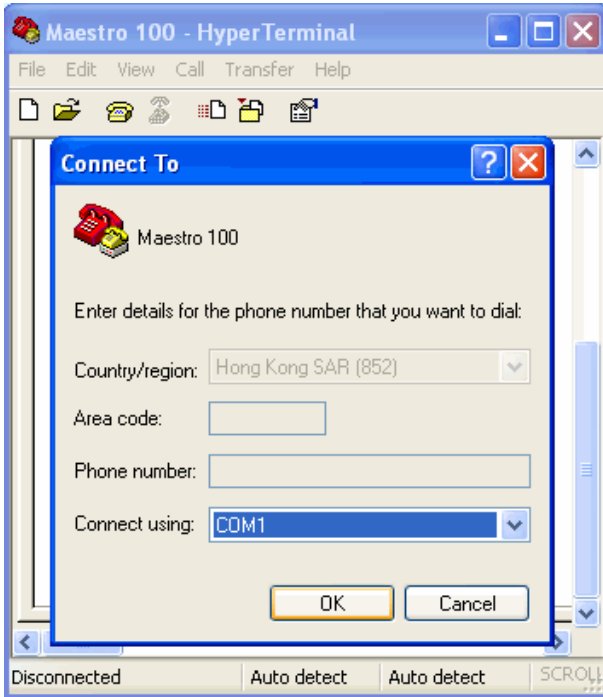

- d. On the terminal screen, type "AT" to check the "OK" response from the modem

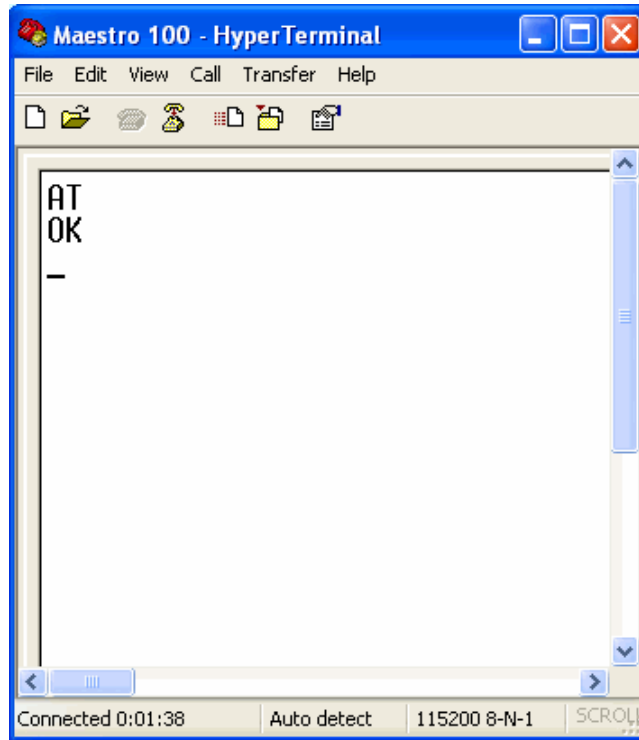

2. Basic operation

Followings are examples of some AT commands. Please refer to the AT command document for a full description.

Note: Issue AT+CMEE=1 to have extended error code (+CME ERROR)

Description	AT commands	Modem response	Comments
Network registration checking	AT+CREG?	CREG=<mode>,1	Modem registered to the network
		CREG=<mode>,2	Registration lost, re-registration attempt
		CREG=<mode>,0	Modem not registered on the network, no registration attempt
Receiving signal strength	AT+CSQ	+CSQ:20,0	The first parameter has to be at least 15 for normal communication
Receiving an incoming call		RING	An incoming call is waiting
	ATA		Answer the call
Make a call		OK	
	ATD1234567;		Don't forget the ";" at the end for "voice" call
		OK	Communication established
		CME ERROR : 11	PIN code not entered (with + CME = 1 mode)
		CME ERROR : 3	AOC credit exceeded or a communication is already established
Make an emergency call	ATD 112;		Don't forget the ";" at the end for "voice" call
		OK	
Communication loss		NO CARRIER	
Hang up	ATH		
		OK	
Enter PIN code	AT+CPIN=1234		
		OK	PIN Code accepted
		+CME ERROR : 16	Incorrect PIN code (with +CME = 1 mode)
		+CME ERROR : 3	PIN already entered (with +CME = 1 mode)
Saves parameters in non-volatile memory	AT&W		
		OK	The configuration settings are stored

CHAPTER 4: SPECIFICATIONS

- Quad-Band GSM 850 / 900 / 1800 /1900 MHz
- Support Data, Voice and Fax
- ETSI GSM Phase 2 + compliant
- LED Bar indication of RSSI, Network Registration, Up/Down data Traffic and EDGE availability
- Group 3 FAX support (Class 1 and 2)
- GPRS Class 10 / EDGE Class 10
- Real time clock backup by Super-Capacitor
- Built-in watchdog chip to prevent modem lock-up
- Control via AT command (GSM 07.05, GSM 07.07 and WAVECOM proprietary)

Power requirements:

Input voltage range	5V - 32V
Rated current	500 mA

Typical current consumption:

	@5V	@12V	@32V
GSM900 communication mode PCL=5	310mA	130mA	50mA
DCS1800 communication mode PCL=5	240mA	100mA	40mA
GPRS900 class 10 PCL=5	520mA	220mA	80mA
GPRS1800 class 10 PCL=0	390mA	160mA	70mA
Idle mode	80mA	35mA	18mA
Idle mode with power saving	75mA	34mA	15mA

Interfaces:

- SIM Holder
- 9 pin sub-D connector
- 4 pin power supply connector
- SMA antenna connector (50 Ohm)
- Din rail mountable
- Expansion slot for add-on module for customized functions

Dimensions

- Overall size: 79mm x 84mm x 27mm
- Weight: 100g
- Temperature range: -20°C to +55°C Operating ETSI compliant
-35°C to +85°C Operating functional
-40°C to +85°C Storage

CHAPTER 5: APPENDIX

Factory settings

The modem has the following factory settings. Please refer to the AT command document for the meaning of each setting.

Related AT commands	Factory settings	Description
AT+IPR	115200	DTE-DCE data rate
AT+IFC	2,2	DTE-DCE flow control
AT+ICF	3,4	DTE-DCE character framing
ATE	1	ECHO
AT&C	1	DCR signal
AT&D	2	DTR signal
ATQ	0	Result code suppression
ATV	1	Response format
AT&S	1	DSR signal
ATSO	0	Auto answer
AT+CLIP	0	Calling line ID presentation
AT+CRLP		Calling line ID restriction
AT+CSCS	"PCCP437"	
AT+CMGF	1	Message format
AT+CSMP	1,67,0,0	Test mode parameters
AT+CNMI	0,1,0,0	New message indication

CHAPTER 6: TROUBLESHOOTING

1. The modem's LED does not light

Check if the modem has been properly connected to a 5 - 32V power supply

Check if the power connector is properly inserted

Check the fuse on the power cord

2. The modem's LED lights but does not blink long time after power up

Check if a valid SIM card has been properly inserted

Check if the SIM card has been locked (refer to AT+CPIN command in AT command guide)

Check if the external has been properly connected to the modem

Check if the network coverage is available

3. The modem does not respond to the terminal program

Check if the RS232 cable has been properly connected

Check if your program has proper settings. Factory setting of the modem is:

- 115200
- 8 data bits
- No parity bit
- 1 stop bit